

## INSTALLATION INSTRUCTION

### SINGLE HOLE BATHROOM FAUCET

20S0604C/20S0604NA/20S0604NJ/20S0604PA

### ※ACCESSORIES CHECKING

#### LIST OF THE STANDARD ACCESSORIES:

Please double-check the accessory list hereinafter and contact our company for any unconformity.

#### Remarks:

1. Without affecting their performing, accessories may be changed without further notice;
2. Drawings for reference only, Product size & shape refer to actual faucet.

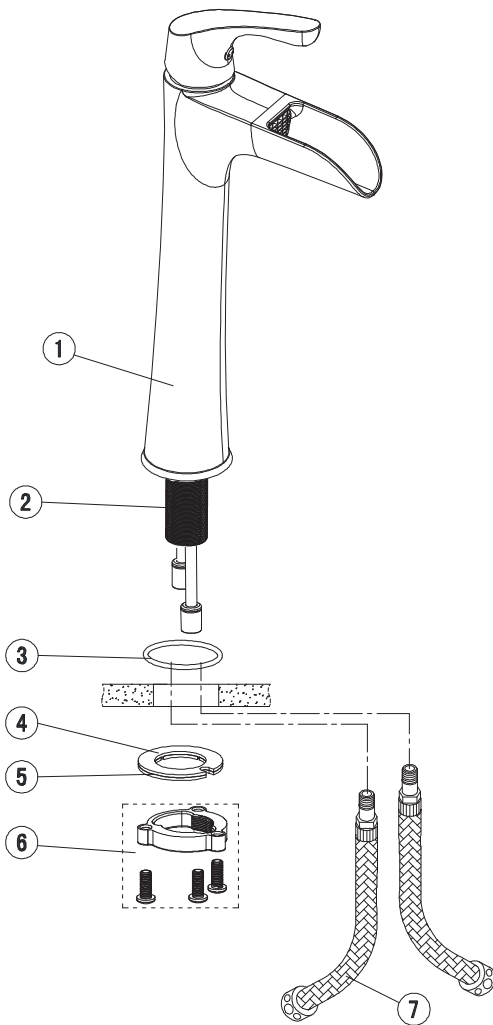

Code	The Accessory List	Quantity
1	Main body	1
2	Threaded sleeve	1
3	O-ring	1
4	Rubber washer	1
5	Clamp	1
6	Fixed nut	1
7	Inlet pipe	2
8	Allen key	1
9	Pop-up	2

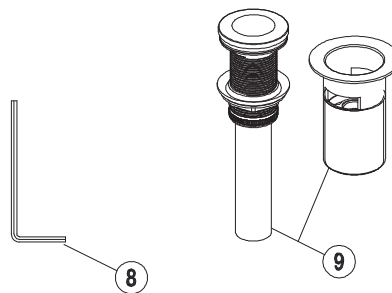

### ※Installation Instructions

- ☆ Do not disassemble the main body, as it has been installed & commissioned correctly & precisely before leaving the factory;
- ☆ To avoid the faucet from jamming, do flush the water pipe before installation;
- ☆ After installation, make sure every joint safely sealed & no leaking;
- ☆ Using condition: Working pressure at 0.05-1.0MPa (including cold & hot water pressure), with applicable water temperature: 4°C-90°C;
- ☆ Make sure to connect the hot/cold inlet pipe correctly, if standing in front, hot water pipe connecting to the left & cold water pipe connecting to the right.

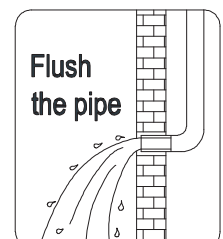
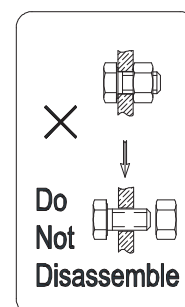

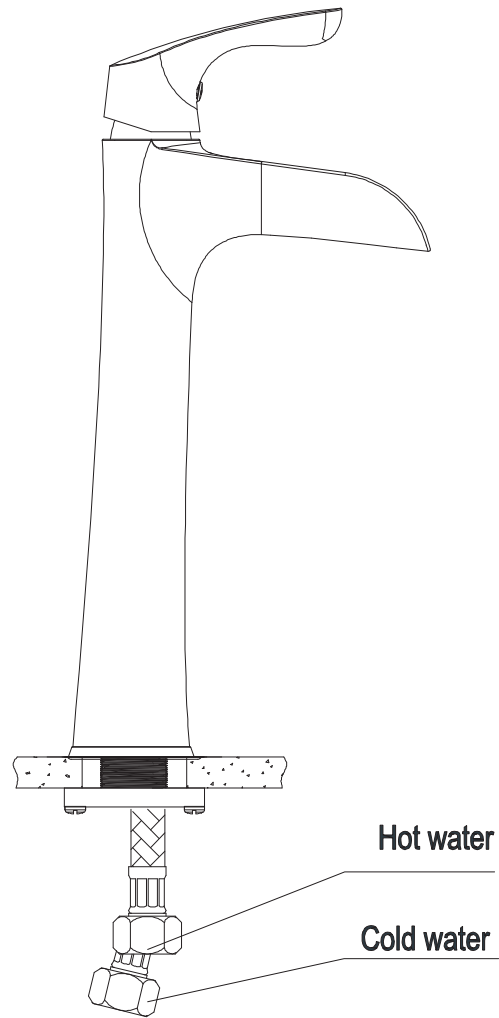
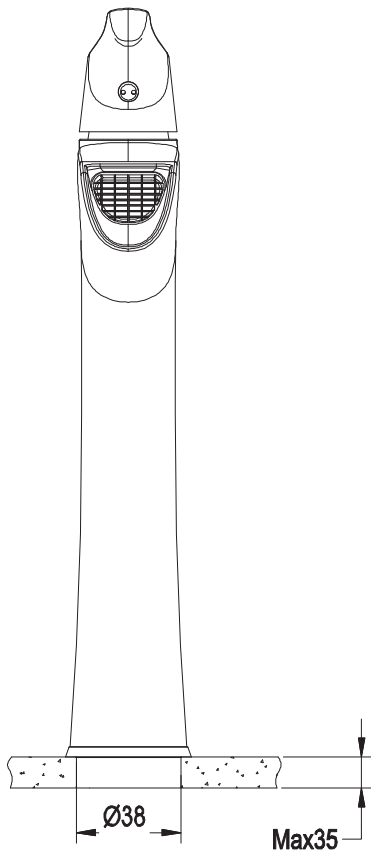

### ※Installation Procedures

- ☆ Make sure the installation holes to be in right size;
- ☆ Connect the main body & water supply pipe with water inlet pipe.

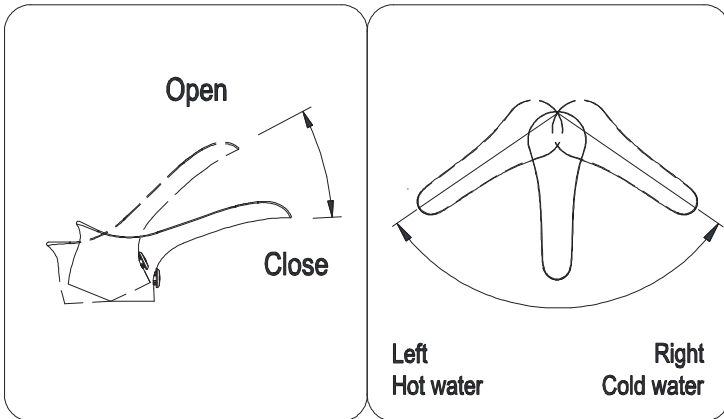

### ※Usage

- ☆How to operate the handle
  1. Raise the handle up for opening water; push it down for close;
  2. Turn the handle to the left to increase hot water flow for higher water temperature, and lower water temperature by operating reversely.
  3. The swivelling can be circled 360°.

### ※Cleaning & Maintenance

- ☆ To keep the product clean & shining, follow the as below:
  1. Flush with clean water & dry with soft cloth only;
  2. If any dirt, clean with soft liquid or transparent glass detergent;
  3. Do not use any scrubbing detergent, polisher, sane-cloth, paper tissue or scraper;
  4. Do not use acid detergent, indissolvable grain-like detergent or soap;
  5. Disassemble the aerator with a coin and clean it when necessary.

